

REVISIONS AND ISSUANCE		
NO.	DATE	DESCRIPTION
1	04152019	PRICING
2	06202019	PERMIT

IVY KIDS EARLY LEARNING CENTER
 LOT COM2I
 CROSS CREEK RANCH
 6407 CROSS CREEK BEND LANE
 FULSHEAR, TX 77441

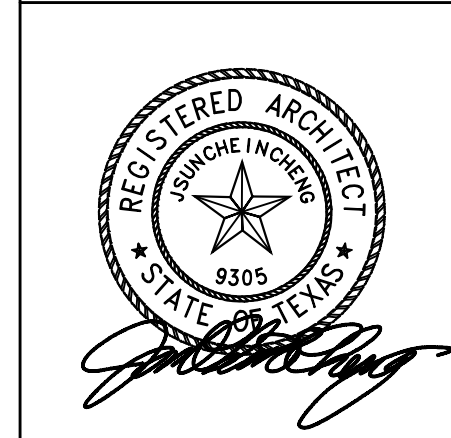

DRAWING TITLE	
INTERIOR ELEVATIONS	
DRAWN BY	CHECKED BY
DATE	JOB NO.
DRAWING NO.	

A-6.7

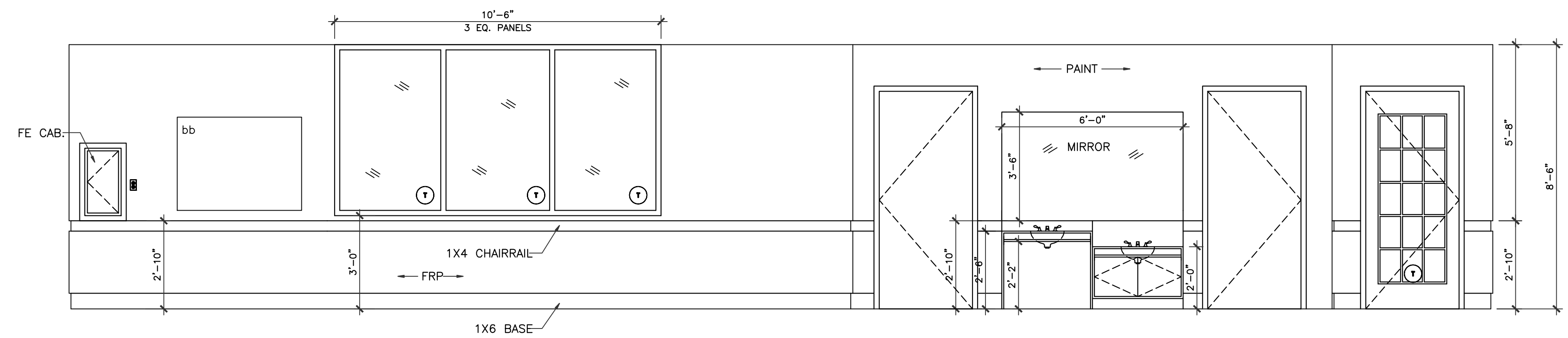

1 CLASSROOM #300 ELEVATION
 3/8" = 1'-0"

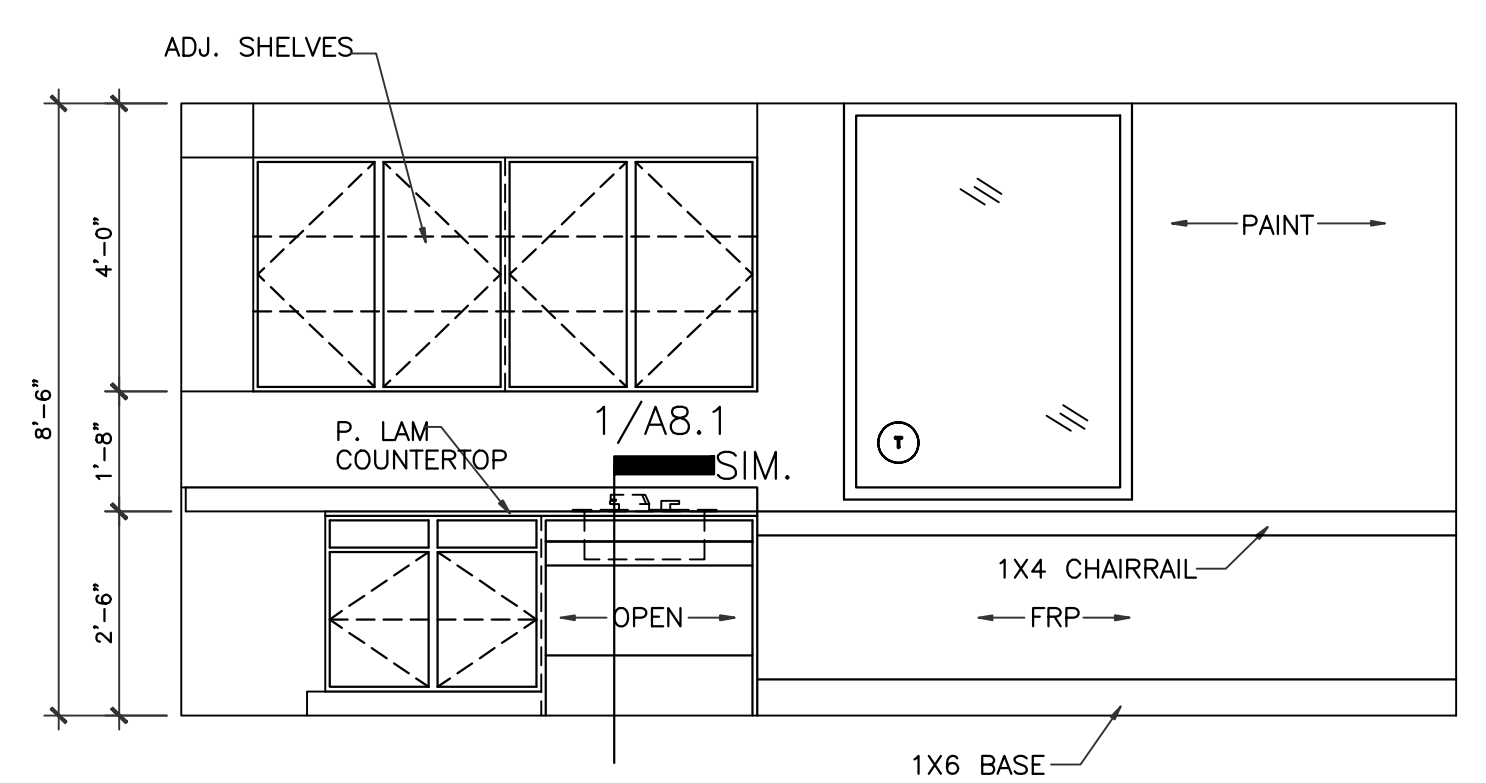

2 LEARNING ELEVATION
 3/8" = 1'-0"

Q: ALLEN+ROTH
 SUGARBRUSH QUARTZ

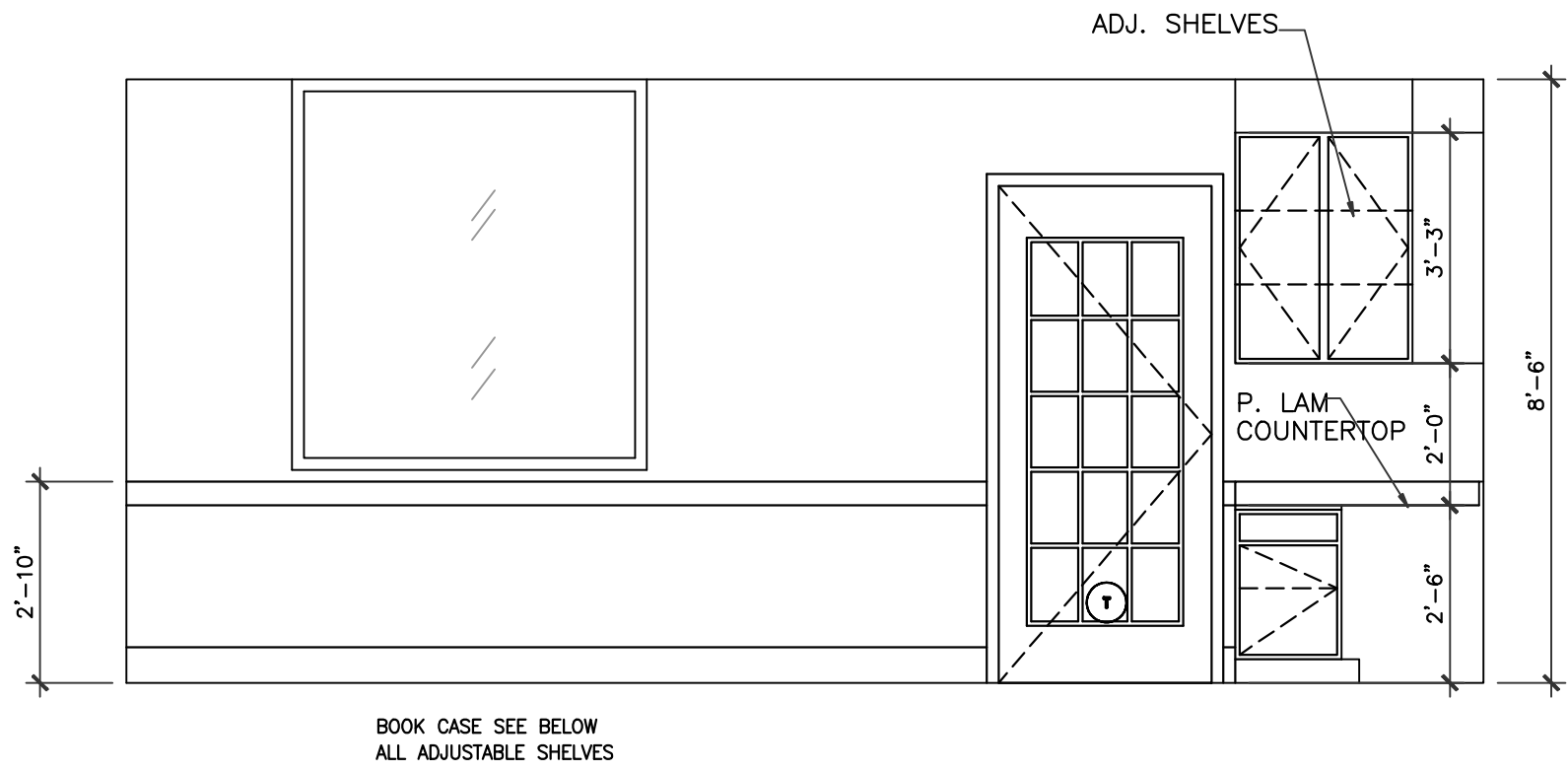

3 LEARNING ELEVATION
 3/8" = 1'-0"

BOOK CASE SEE BELOW
 ALL ADJUSTABLE SHELVES

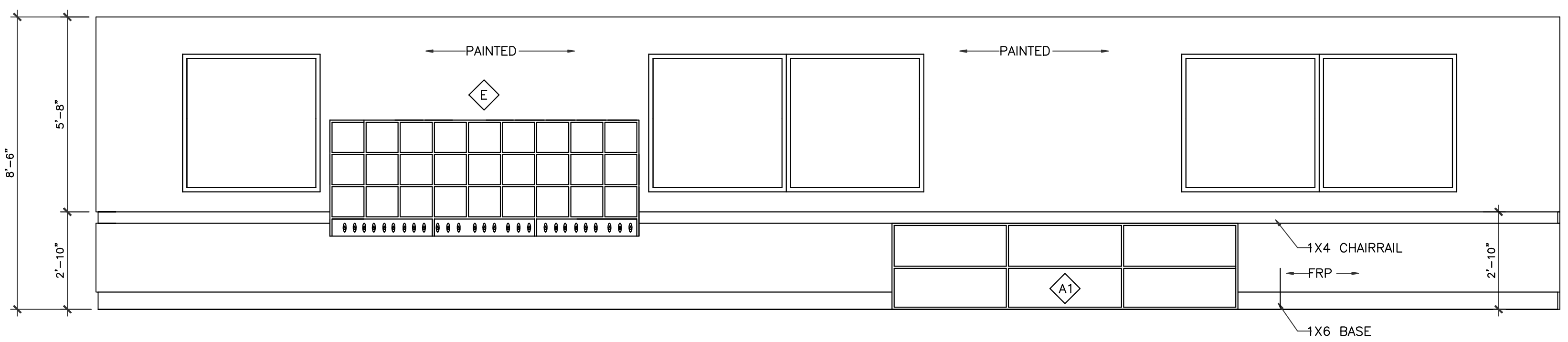

4 CLASSROOM #550 ELEVATION
 3/8" = 1'-0"

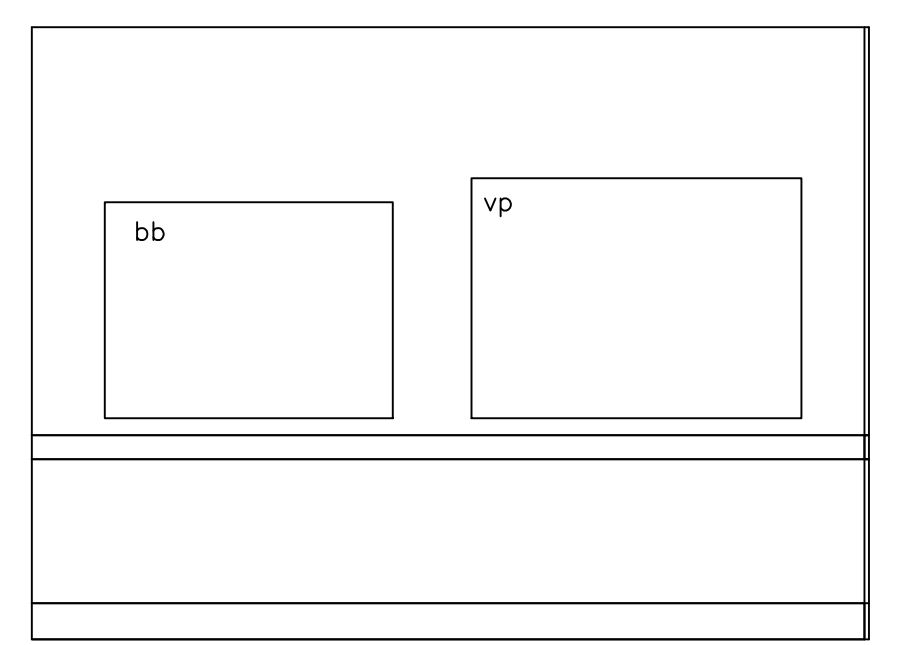

5 CLASSROOM #550 ELEVATION
 3/8" = 1'-0"

LEGEND:
 bb Bulletin Board
 vp vinyl wall pocket chart

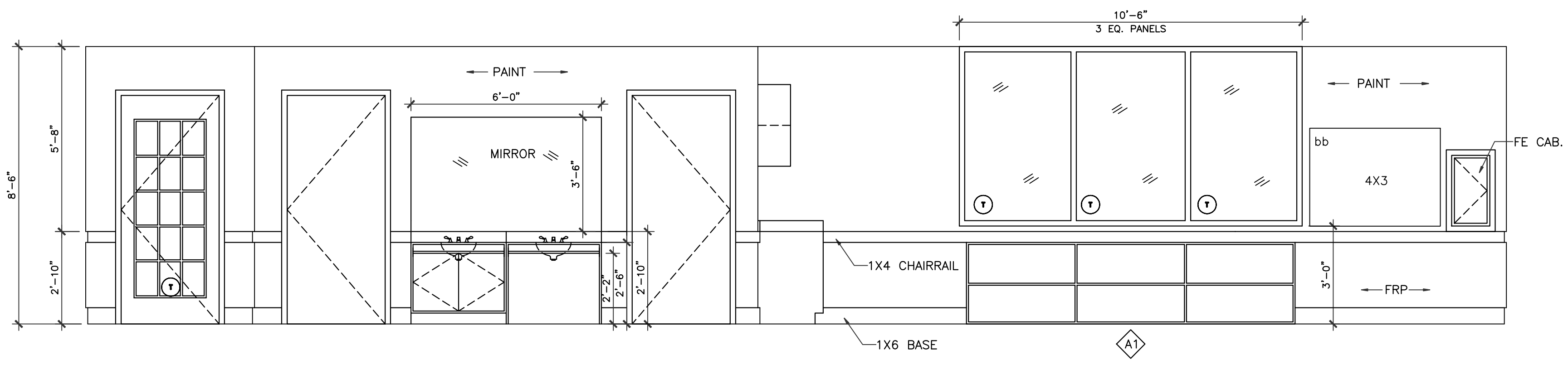

9 CLASSROOM ELEVATION
 3/8" = 1'-0"

CLASSROOM #400
 CLASSROOM #450
 CLASSROOM #500
 CLASSROOM #550 - OPP. HD.

6 7 8 10 NOT USED

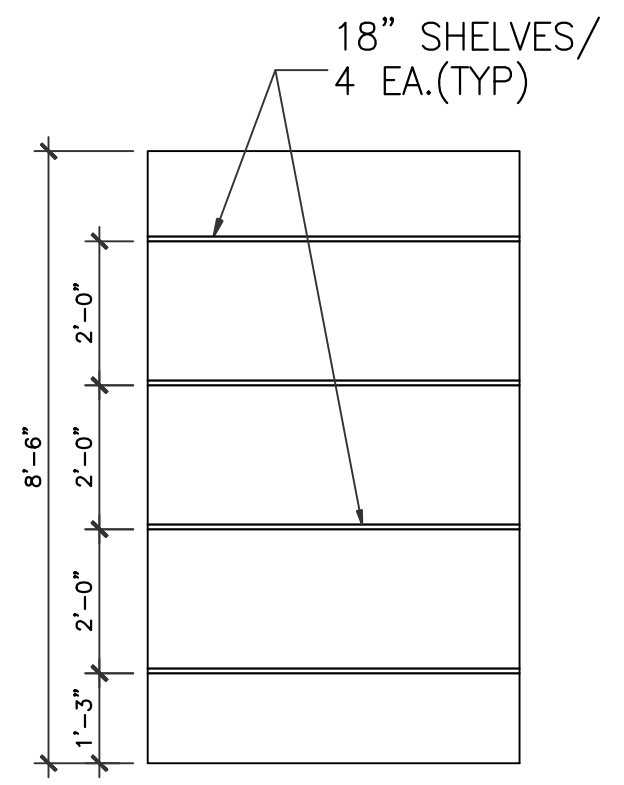

11 STO. ELEVATION(TYP)
 3/8" = 1'-0"